

# CS114

Conducted Susceptibility, Bulk Cable Injection, 10 kHz to 200 MHz up to curve 5 including 4 kHz – 1 MHz common mode requirements for ships & subs

## Test levels

Freq MHz	Curve 1 dBμA	Curve 2 dBμA	Curve 3 dBμA	Curve 4 dBμA	Curve 5 dBμA	Ships, subs dBμA
0.001						77
0.004						77
0.010	37	43	49	57	69	77
1.000	77	83	89	97	109	77
30.000	77	83	89	97	109	
200.000	69	75	81	89	101	

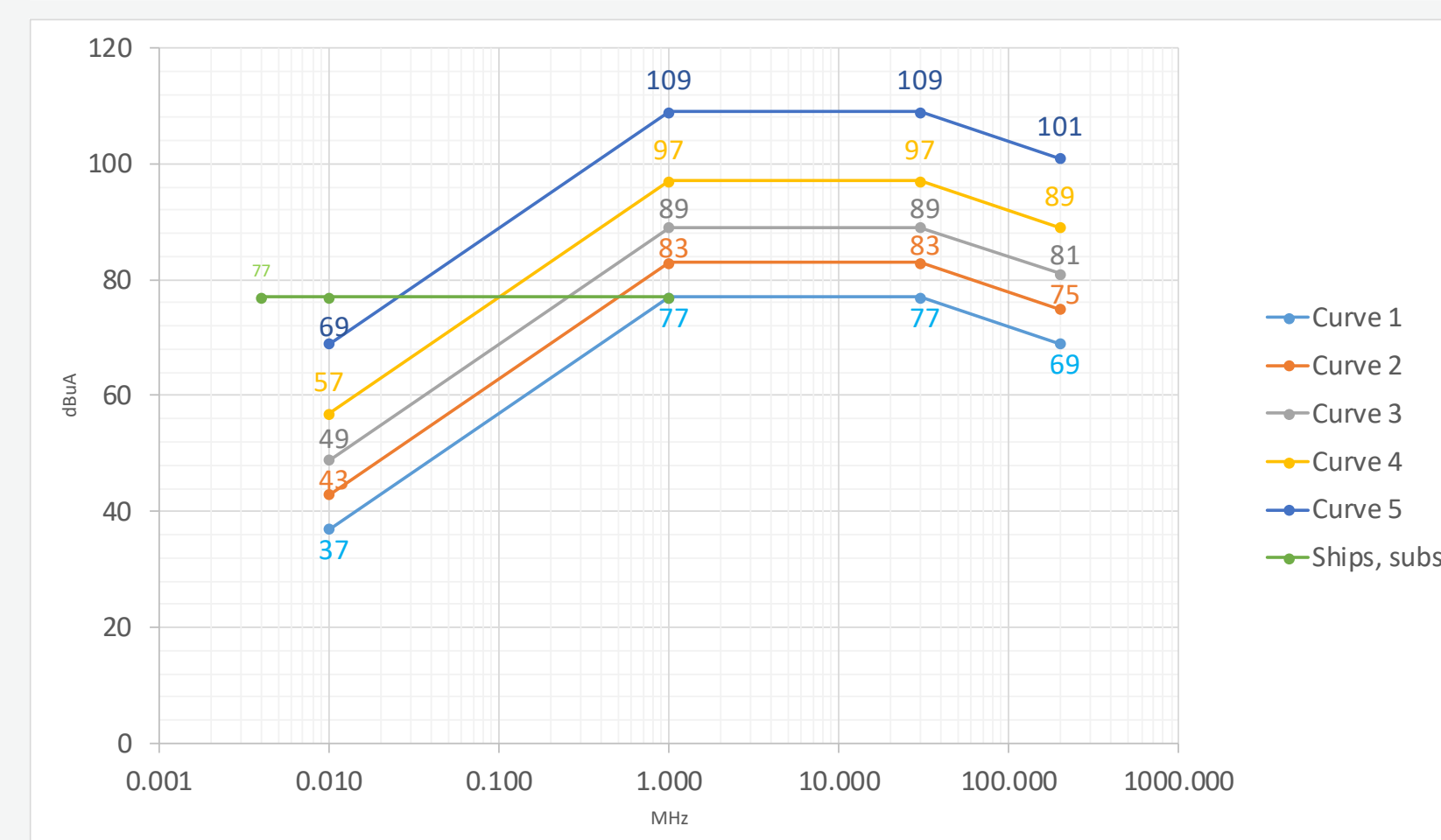

MIL-MG3 test generator and CN-BT6 coupler

Available Plugins for MIL-MG3

MIL-STD-461: CS06 / CS106 / CS115 / CS116  
DO-160 Sections: 17 and 19



The comfortable test suite with system integration options

- Customizable Reports & EUT information
- Predefined Test Setups and Sequences
- Comfortable test management
- Integrate DSO measurements

## Test Setup

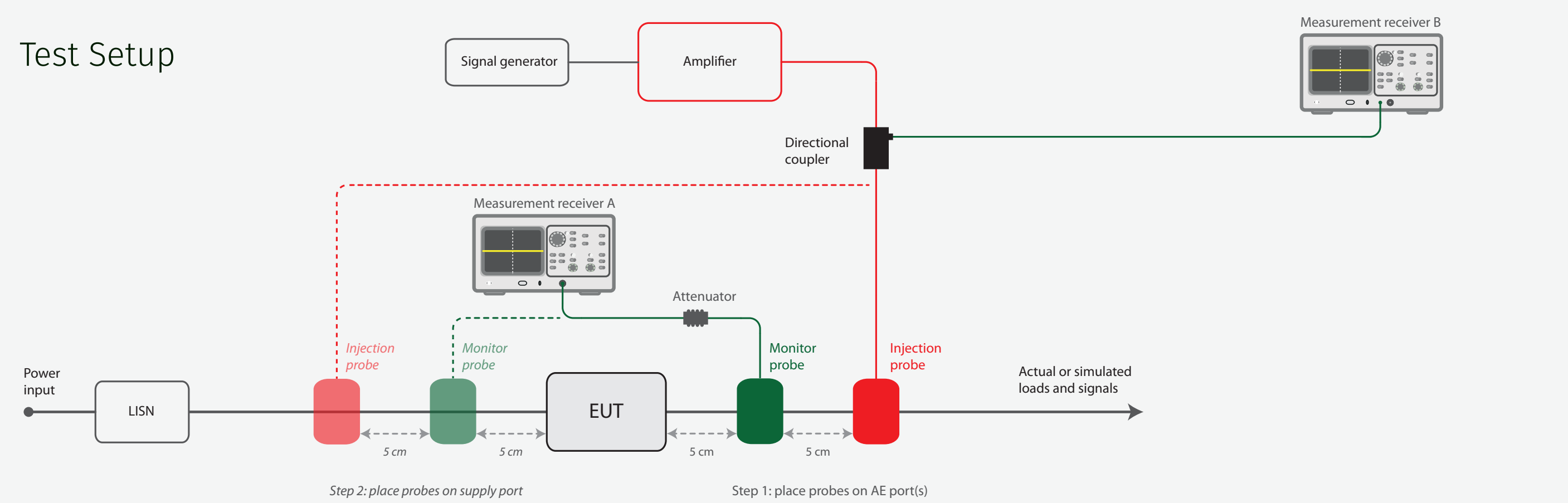

## Verification Setup

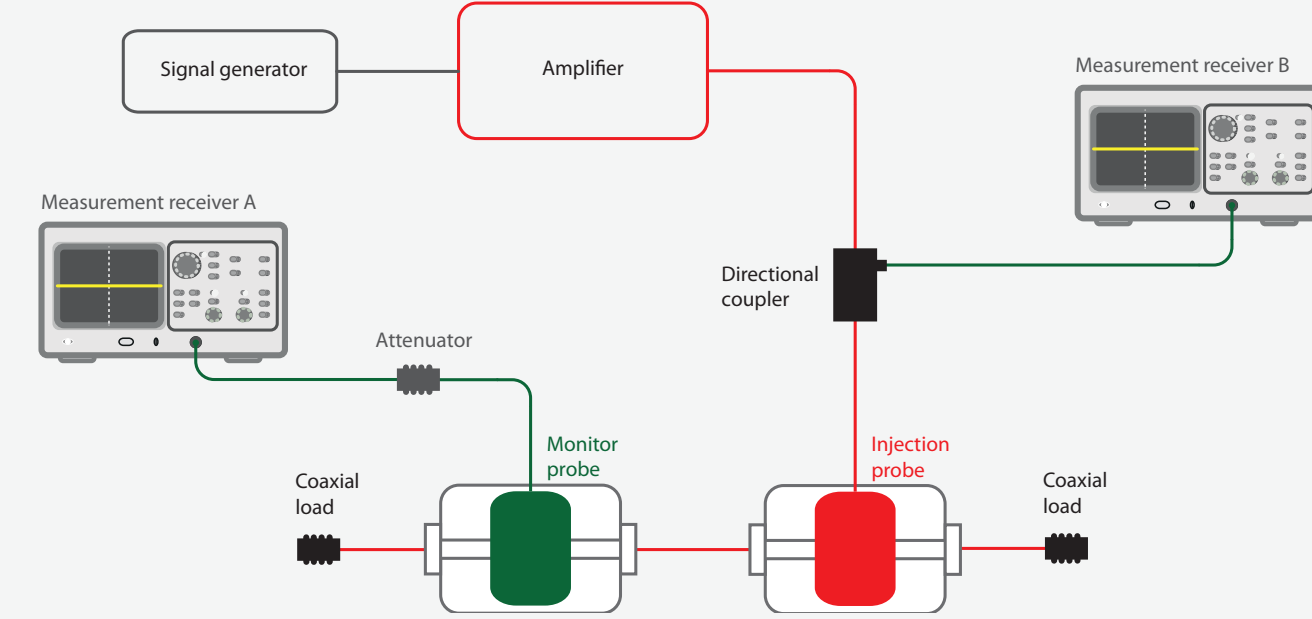

## Calibration Setup

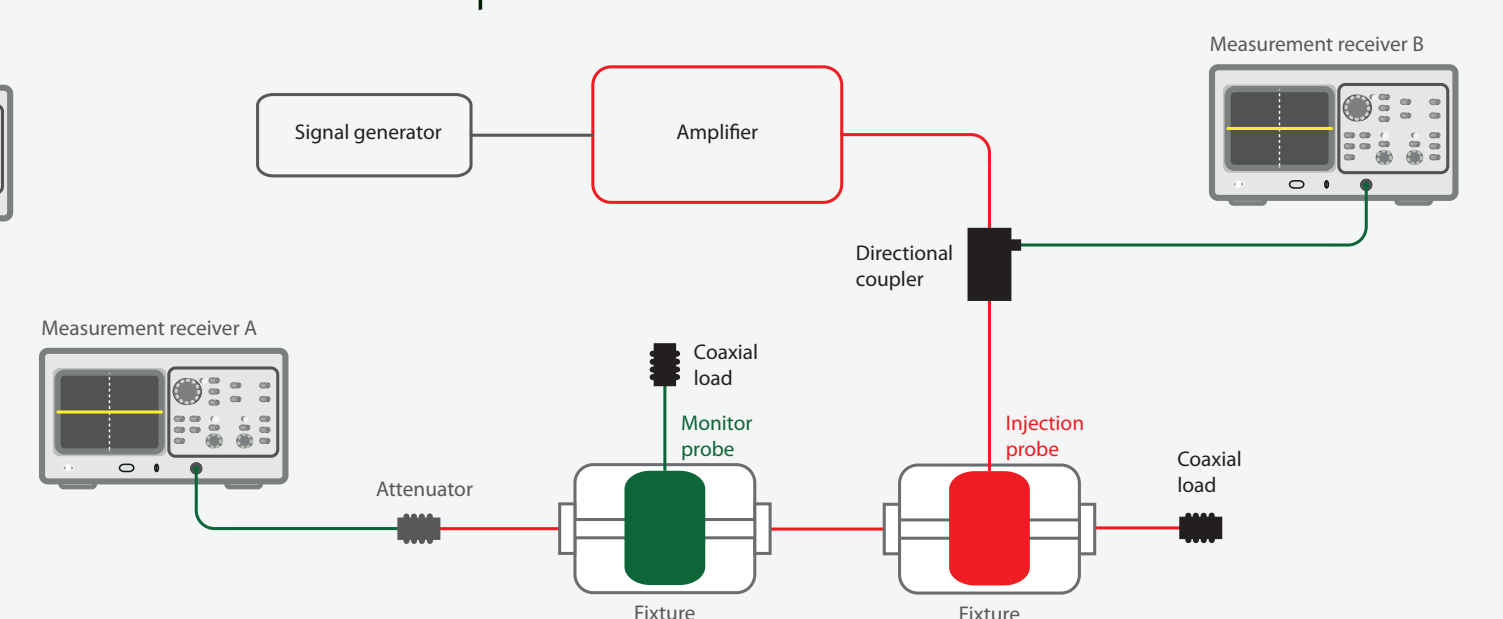

# CS116

Conducted Susceptibility, damped sinusoidal transients, Cables and Power Leads, 10kHz to 100MHz

## Impulse waveform

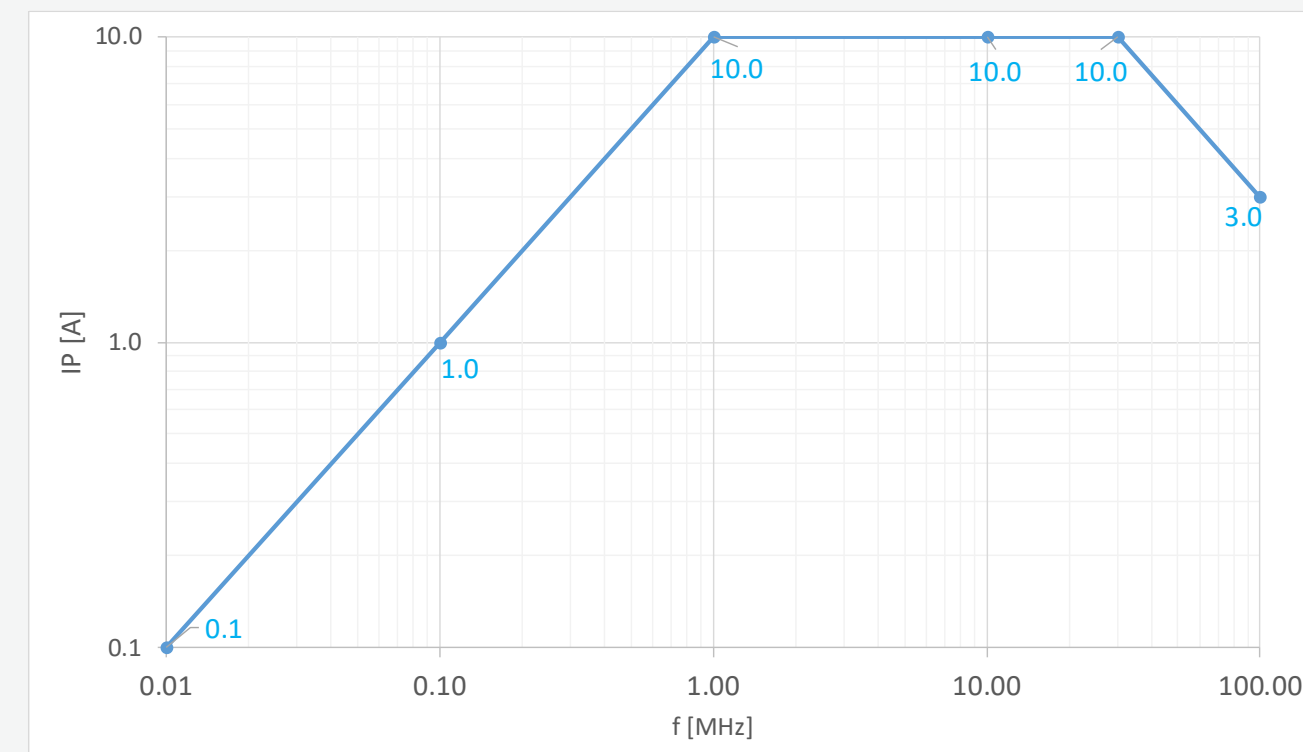
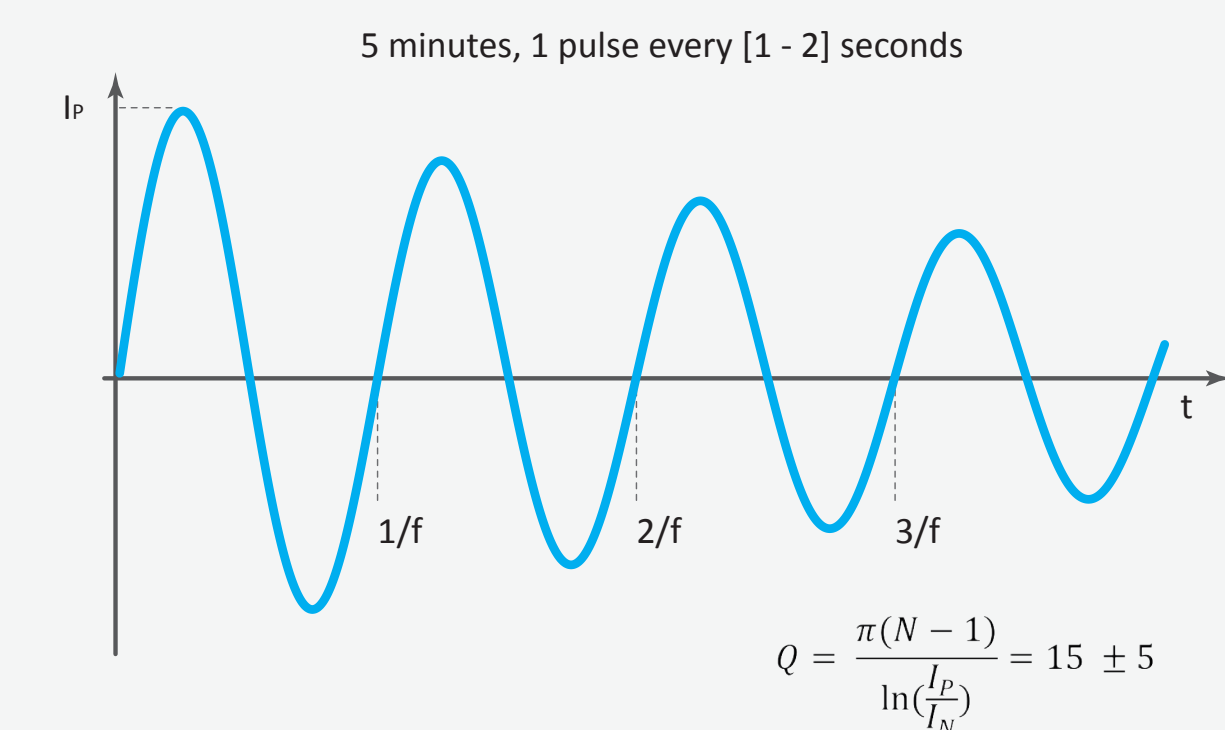

## Test Setup

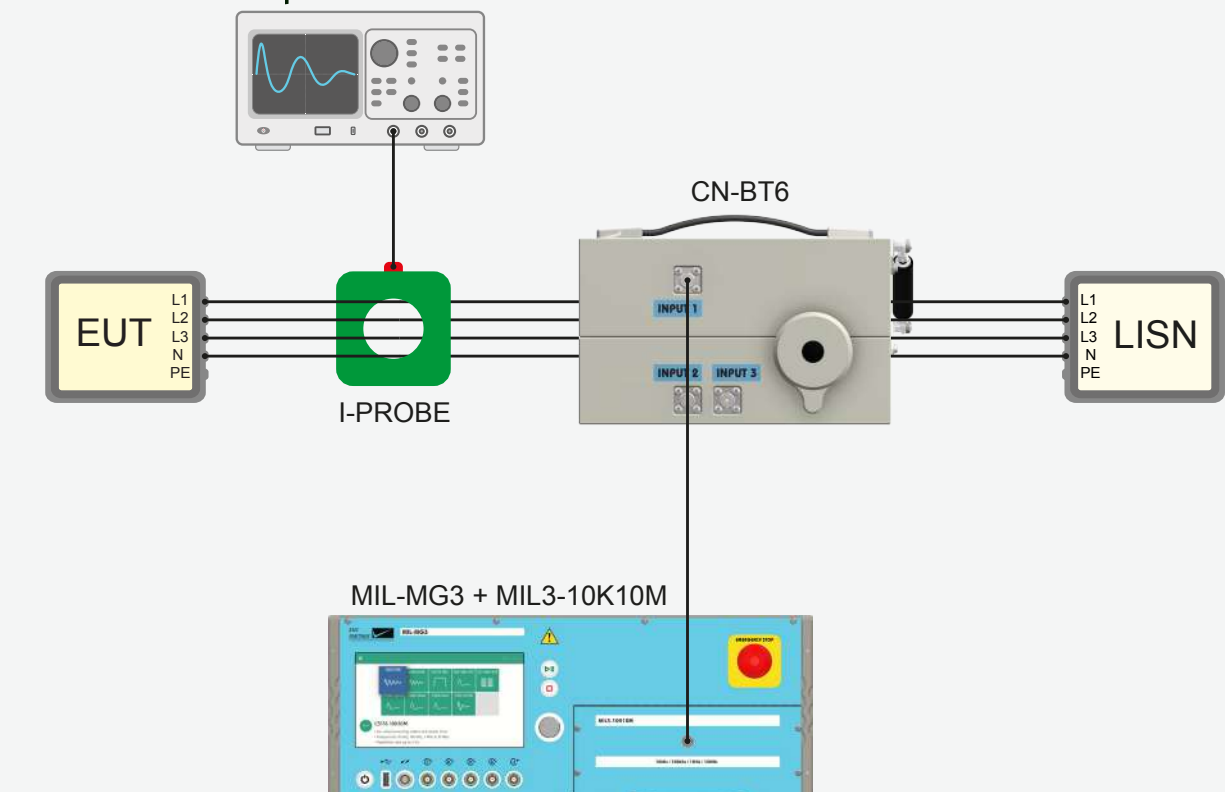

- For 10KHz - 10MHz use Input 1 of CN-BT6 coupler
- For 30MHz - 100MHz use Input 2 of CN-BT6 coupler

## Calibration Setup

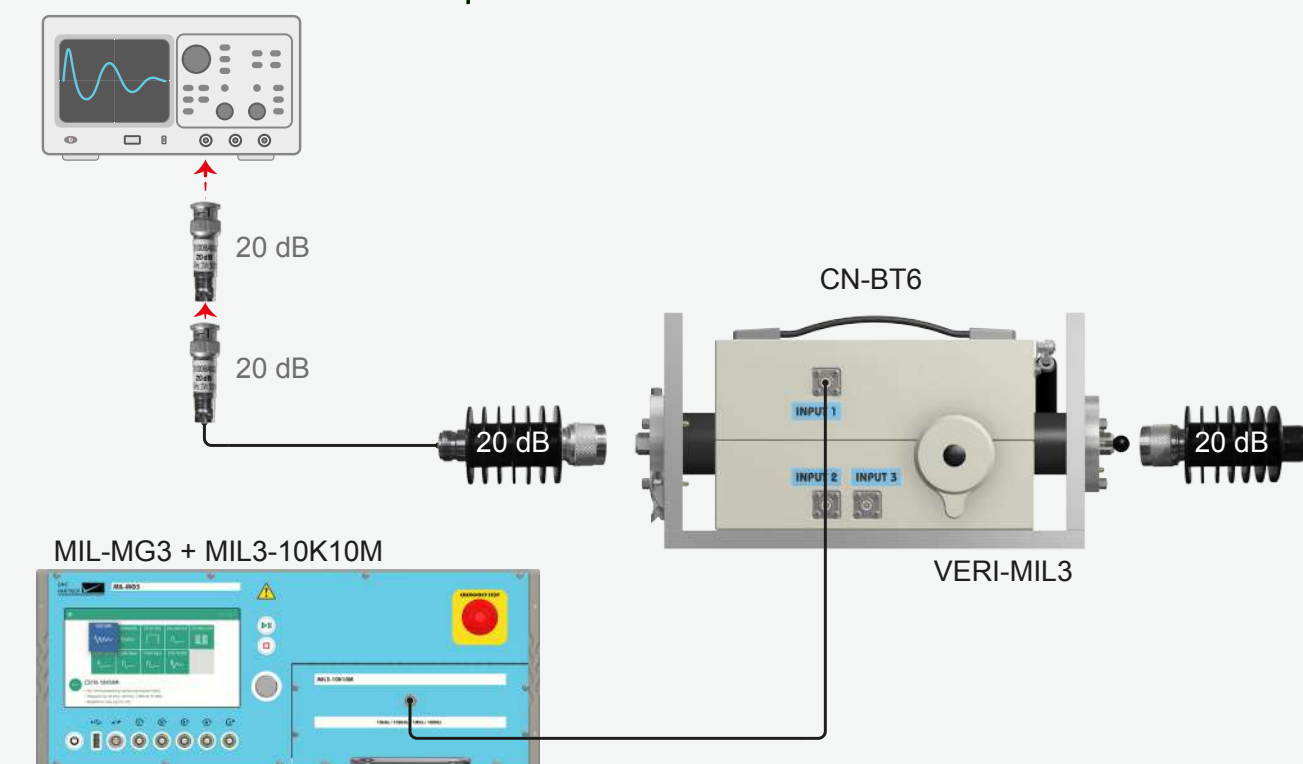

# LIGHTNING INDUCED TRANSIENTS



# CS117

Lightning Induced Transients, Cables and Power Leads

## Multiple Stroke

### WF1 Cable Bundle MS

Level	FS		SS	
	VTest	ITest	VLimit	ILimit
internal	300	600 (60*)	150	150 (30*)
external	750	1500 (150*)	375	375 (75*)

### WF2 Cable Bundle MS

Level	FS		SS	
	VTest	ILimit	VTest	ILimit
internal	300	600	150	150
external	750	1500	375	375

### WF3 Cable Bundle MS

Level	FS		SS	
	VTest	ILimit	VTest	ILimit
internal	600	120 (24*)	300	60 (12*)
external	1500	300 (60*)	750	150 (30*)

### WF4 Cable Bundle MS

Level	FS		SS	
	VTest	ILimit	VTest	ILimit
internal	300	1000 (300*)	75	200 (150*)
external	750	2000 (750*)	187.5	400 (375*)

### WF5A Cable Bundle MS

Level	FS		SS	
	VLimit	ITest	VLimit	ITest
internal	300	1000 (300*)	75	200 (150*)
external	750	2000 (750*)	187.5	400 (375*)

\* low count wire bundles

## Multiple Burst

### Cable Bundle MB (1 & 10 MHz)

Level	WF3	
	VTest	ILimit
internal	360	6
external	900	15

### Cable Bundle MB

Level	WF6H	
	VLimit	ITest
internal	600	30
external	1500	75

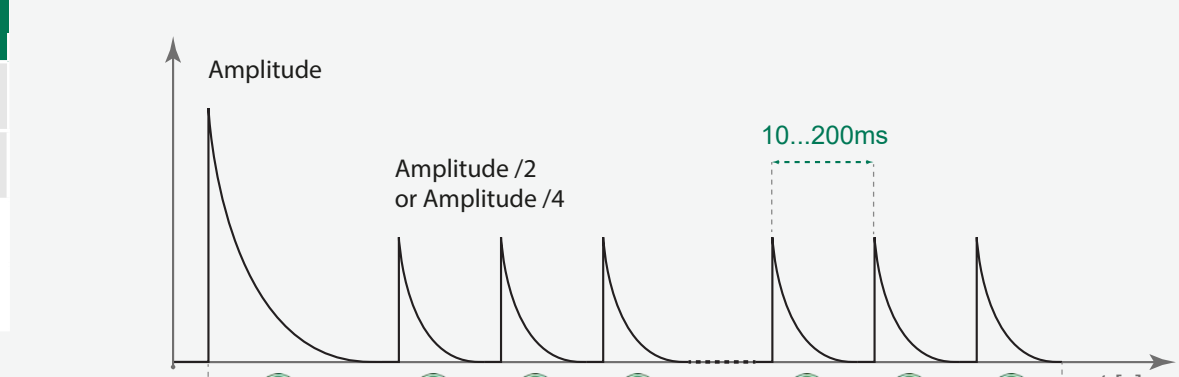
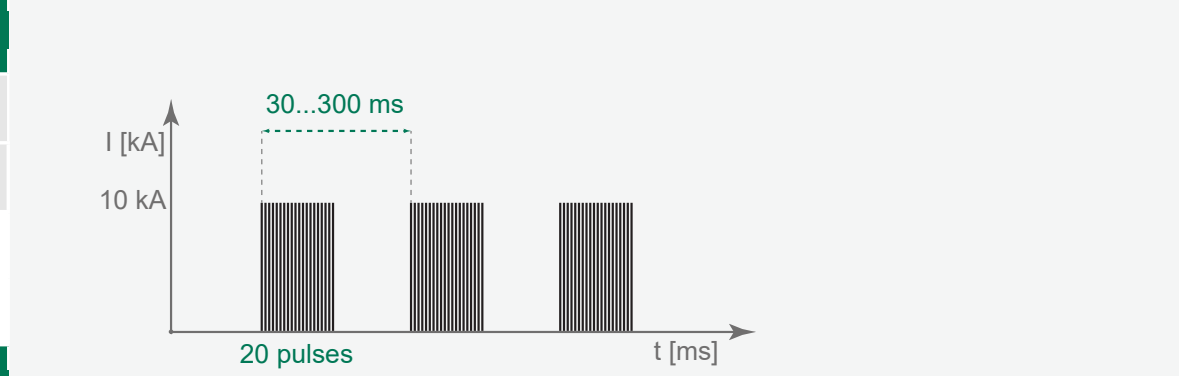
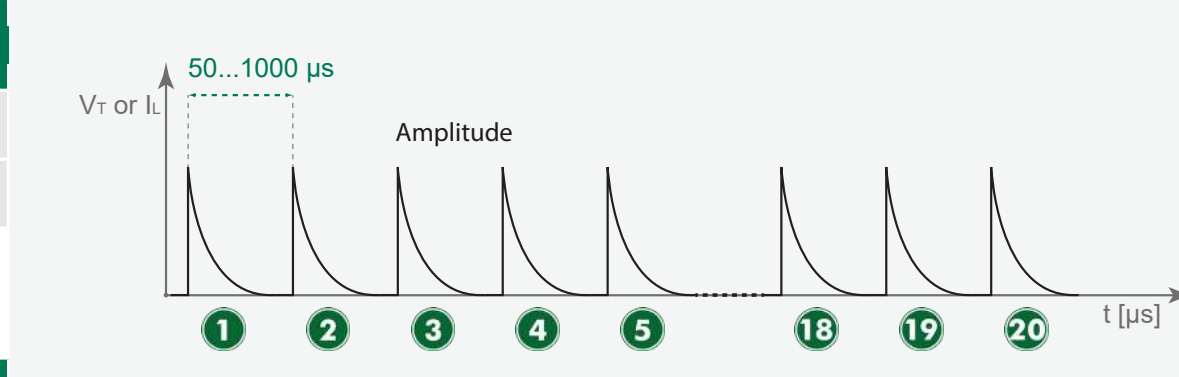

## Your local Contact

Test equipment and further solutions

[www.emc-partner.ch](http://www.emc-partner.ch)



# CS115

Conducted Susceptibility, Bulk Cable Injection, Impulse Excitation

## Impulse waveform

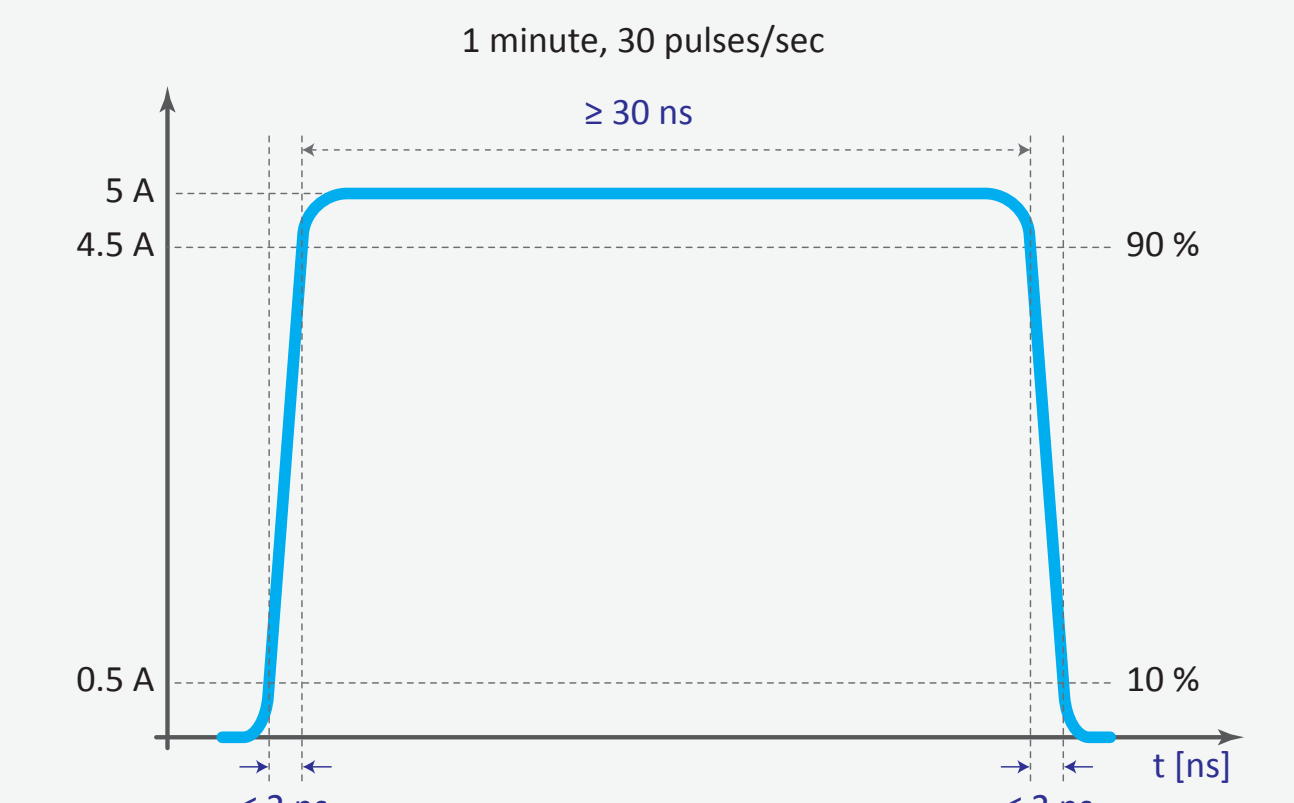

## Calibration Setup

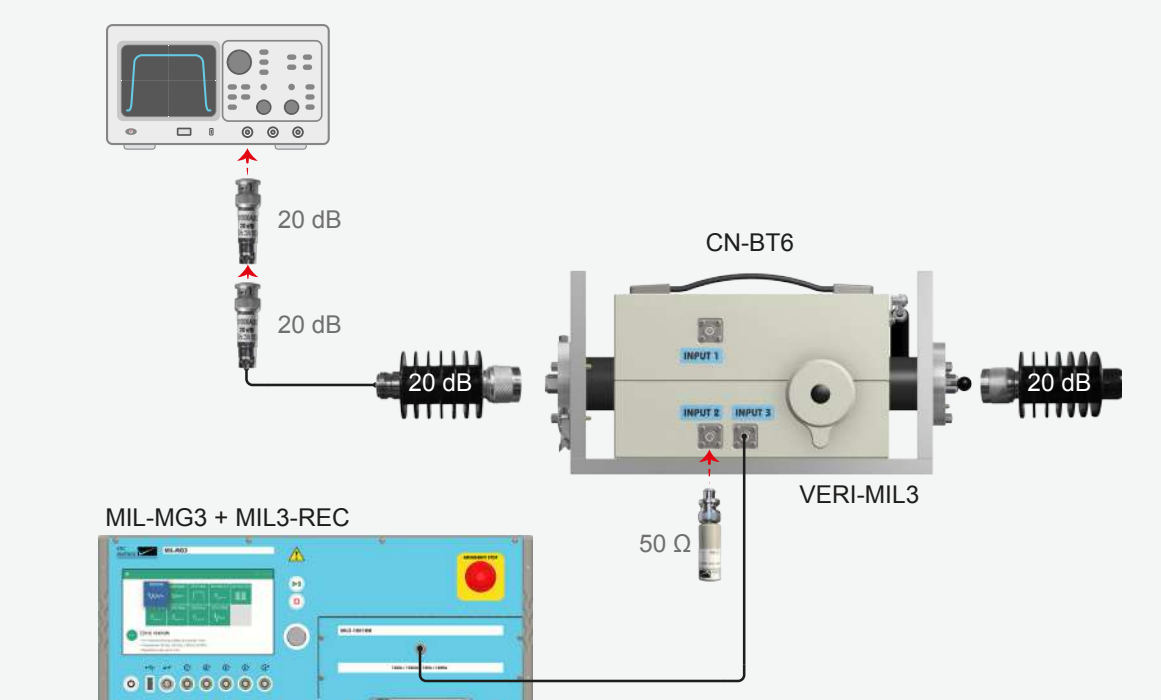

## Verification Setup

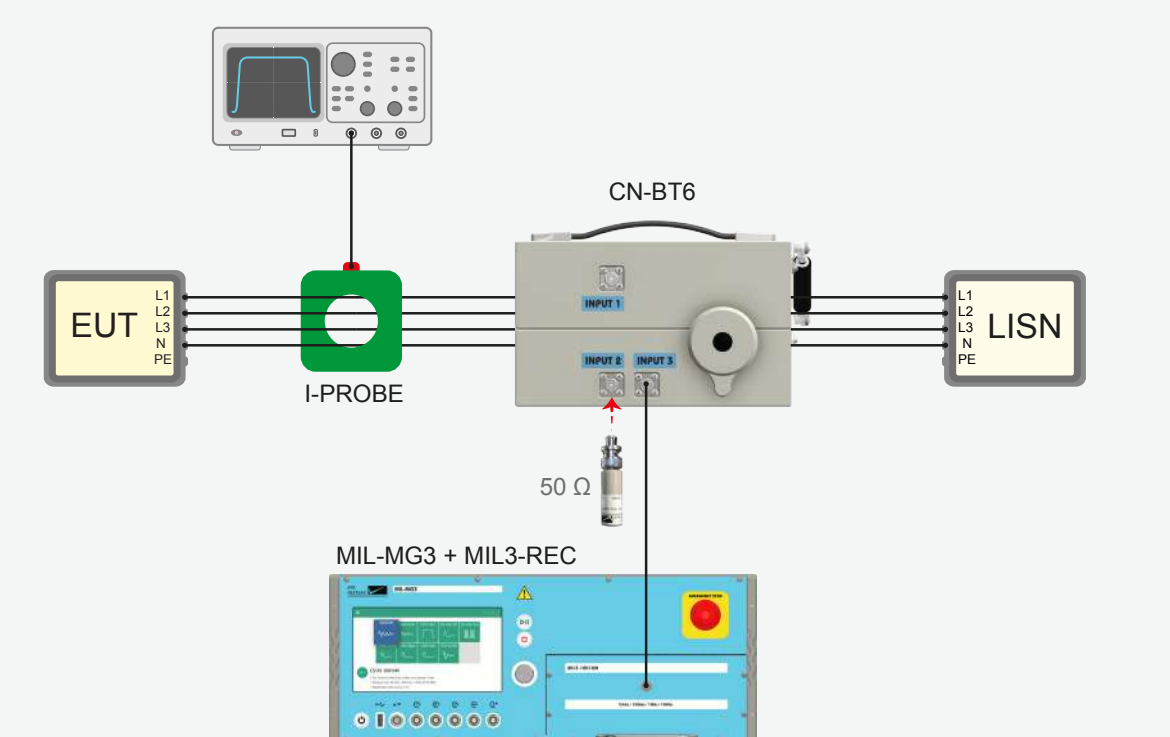

# CS118

Conducted Susceptibility, Personnel Borne ESD

## Impulse waveform

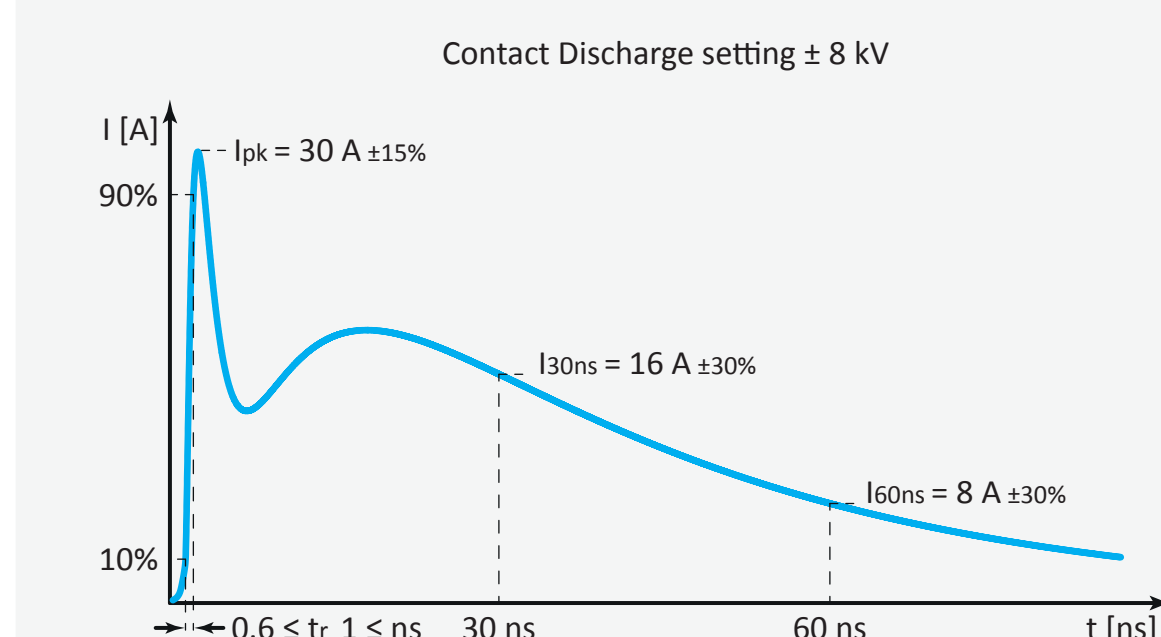

- Ready for CS118 requirements
- Covers IEC61000-4-2 requirements
- Modular architecture
- Wide range of discharge networks
- Light-weight
- Up to 8 hours operating time
- Worldwide known test solution

Level	Voltage [kV]	Method
1	± 2	Air
2	± 4	Air
3	± 8	Contact / Air
4	± 15	Air

## Voltage Calibration Setup

